



Thule Rapid System Kit 4080 Thule Podium Kit 4080

> Instructions

LAND ROVER Discovery (Mk. V), 5-dr SUV, 17-

This kit is only for vehicles with flush side railing.

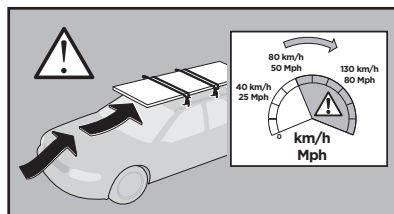
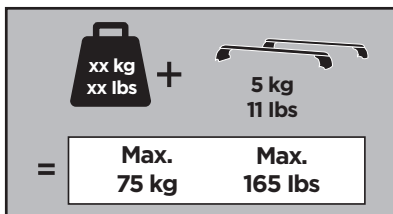
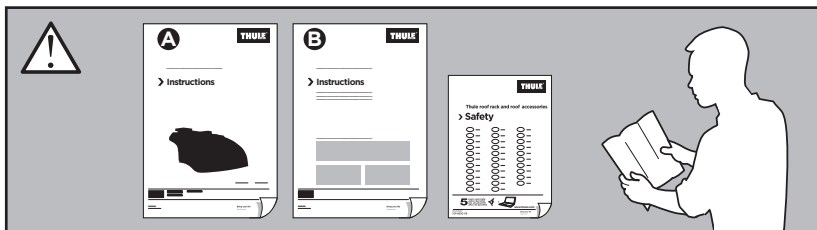

ISO 11154-E

184080
C.20170516
509-4080-01

Bring your life
thule.com

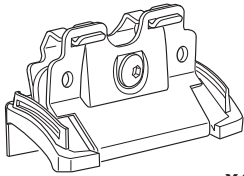

x4



52577

x1



x1

1



Thule Rapid System Foot Pack 753/7531 Thule Podium Foot Pack 460/460R



1



2
1/4

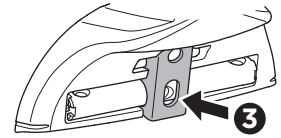

3

2

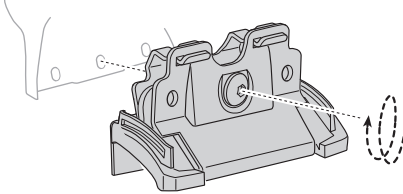

- EN Only a few turns
- DE Nur wenige Umdrehungen
- FR Quelques tours uniquement
- NL Slechts enkele slagen
- IT Solo qualche giro
- ES Sólo algunas vueltas
- PT Apenas algumas voltas
- SV Endast några varv
- DK Kun nogle få omgange
- NO Bare noen få omdreininger
- FI Vain muutama kierros

- ET Ainult mõni pööre
- LV Tikai daži apgriezieni
- LT Tik keli pasukimai
- PL Wystarczy kilka obrotów
- RU Только несколько оборотов
- UK Лише декілька обертів
- BG Само няколко завъртания
- CS Pouze několik otáček
- SK Len niekoľ'ko otáčok
- SL Le nekaj obratov
- HR/BiH Samo nekoliko okreta
- RO Doar câteva rotiri
- HU Csak néhány fordítás
- EL Μόνο λίγες περιστροφές
- TR Yalnızca birkaç tur

بعض دورات فقط

AR

רק מספר סיבובים

HE

- ZH 仅几圈
- JA 2～3回転のみ
- KO 몇 번만 돌리면 됨
- TH เพียงสองสามรอบ

3

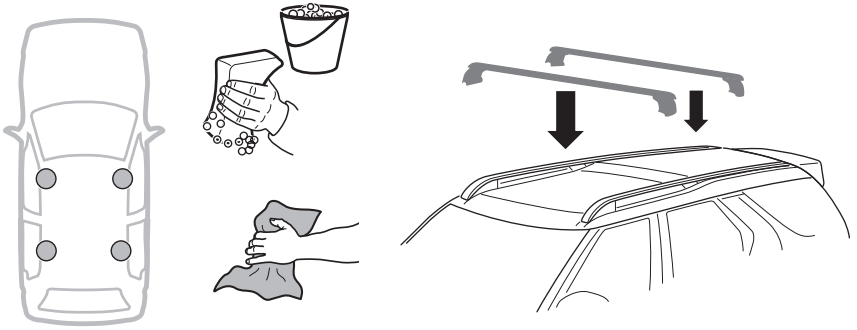

4

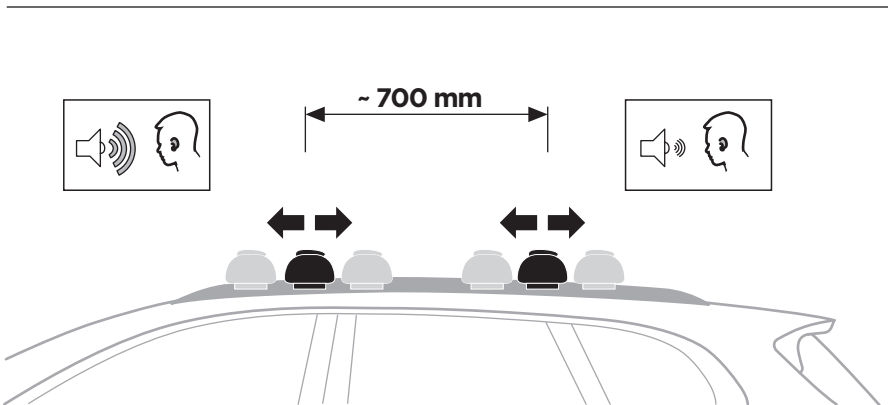
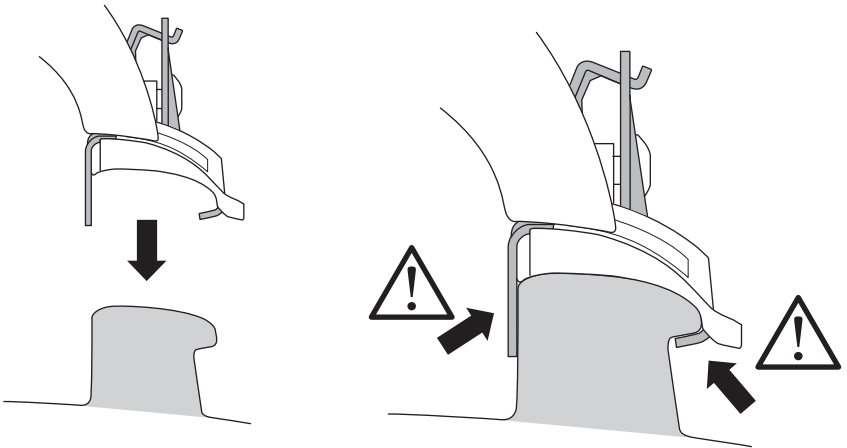

5

- | | | | |
|-----------|---|---------------|---|
| EN | Tighten alternately | UK | Затягти по чергово |
| DE | Die Schrauben abwechselnd anziehen | BG | Затегнете последователно |
| FR | Serrer alternativement chaque côté | CS | Pokřetla багаžníka dokřečaj dokřečaj naprzemiennie. |
| NL | Afwisselend aan de linker- en de rechterkant aandraaien | SK | Dotahujte striedavo |
| IT | Alternare il serraggio delle viti | SL | Privijajte izmenično |
| ES | Apretar alternativamente | HR/BIH | Naizmjenično zategnite |
| PT | Aperte alternadamente | RO | Strângeți alternativ |
| SV | Dra åt växelvis | HU | Egy mástól függetlenül szorítandó |
| DK | Spænd skiftevis | EL | Σφίγγετε εναλλάξ |
| NO | Trekk til vekselvis | TR | Dönüşümlü sıkın |
| FI | Kierrä vuorotellen | | إحكام الربط بالتناوب AR |
| ET | Pinguldage vaheldumisi | | חזק לסימון HE |
| LV | Pievelciēt pamīšus | ZH | 交替拧紧 |
| LT | Užsukinėkite pakaitomis | JA | 左右交互に締めつけてください |
| PL | Śruby dokręcaj naprzemiennie | KO | 번갈아 조이기 |
| RU | Затягивайте попеременно | TH | ขันในแบบสลับ |

