

Kit 4013

BMW X1, 5-dr SUV, 09- / *11-

*North America

This kit is only for vehicles with flush or integrated side railing.

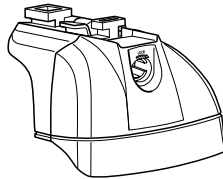

460R
753

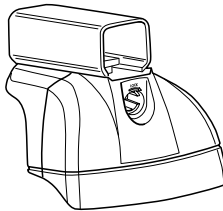

460

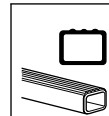

Kit

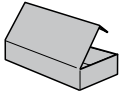

753

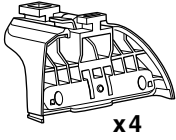

x4



x4



x4



16 mm

x8

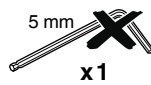

5 mm

x1



x4



x1

460R

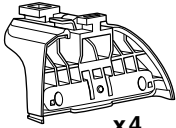

x4



x4



x4



16 mm

x8

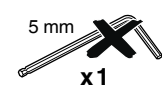

5 mm

x1



x4

460

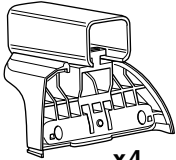

x4



x4



x4



16 mm

x8

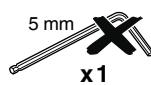

5 mm

x1



x4

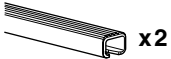
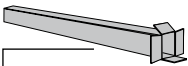

x2



x2

23 mm



x1

17 mm



x2

23 mm

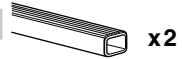

x2

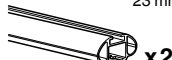

x2

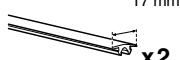

x2

23 mm

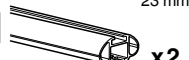

x2



x4

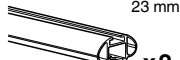

x2



x4



x4

1

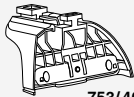

753/460R

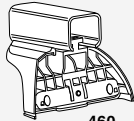

460

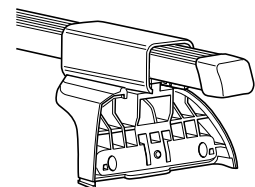
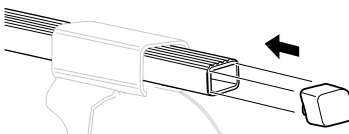
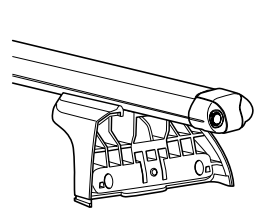
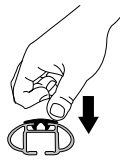
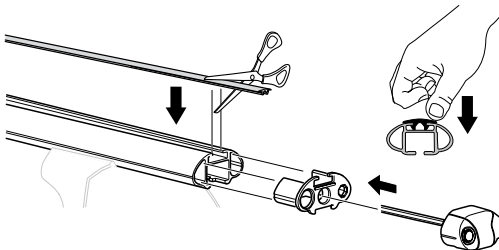
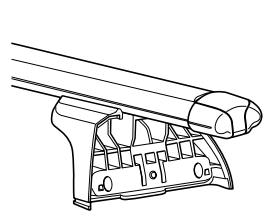
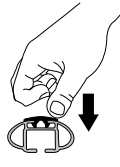
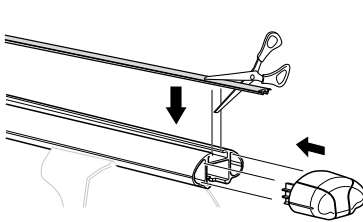
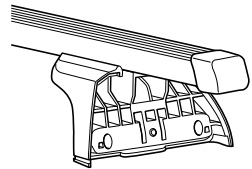
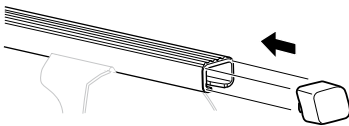
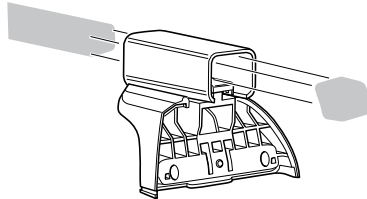
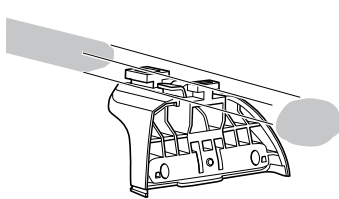

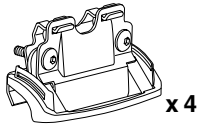
2**i**

| | | | | | |
|------------|---------------------------|------------|--------------------------------|------------|--------------------------|
| GB | Only a few turns | EST | Ainult mõni pööre | HR | Samo nekoliko okreta |
| D | Nur wenige Umdrehungen | LAT | Tikai dažī apgriezieni | HU | Csak néhány fordítás |
| F | Quelques tours uniquement | LIT | Tik keli pasukimai | GR | Μόνο μερικές στροφές |
| NL | Slechts enkele slagen | PL | Wystarczy kilka obrotów | TR | Yalnız birkaç kez çevirm |
| I | Solo qualche giro | RU | Достаточно нескольких оборотов | 中文 | 只有几个转向 |
| E | Sólo algunas vueltas | CZ | Pouze několik otáček | 한국어 | 두 세번만 |
| PT | Noções básicas | SK | Len niekoľko otáčok | 日本語 | 数回転のみ |
| S | Endast några varv | SLO | Le nekaj obratov | ไทย | หมุนเพียงไม่กี่รอบ |
| FIN | Vain muutama kierros | | | | |

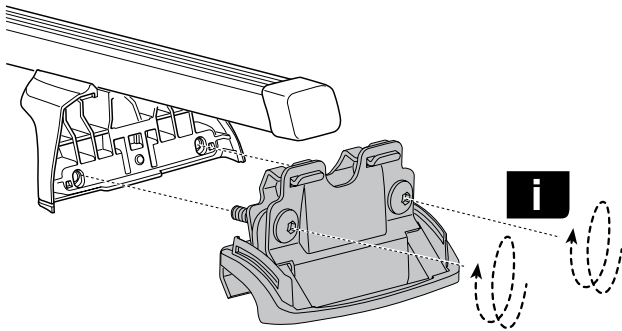
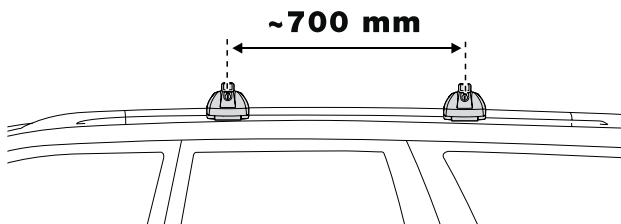
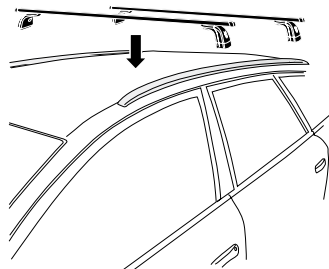
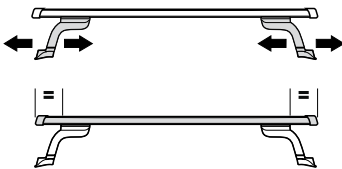
**3**

4

A

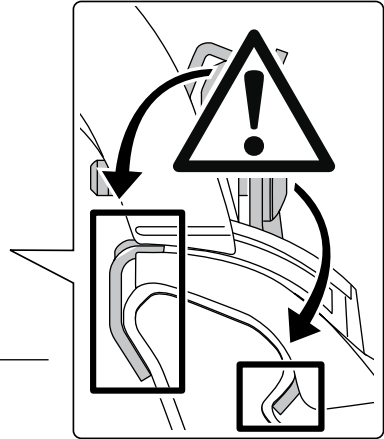
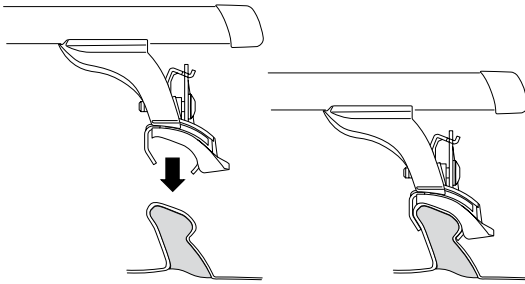

B

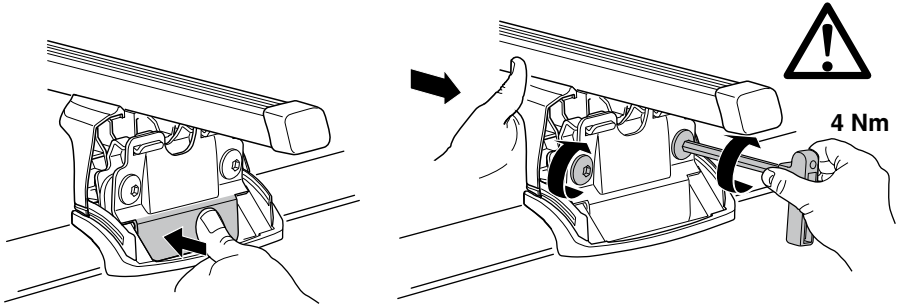
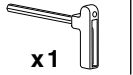

GB/US
D
F
NL
I
E
PT
S
FIN
EST
LAT
LIT
PL
RU

Tighten alternately
Die Schrauben abwechselnd
anziehen
Serrer alternativement chaque côté
Afwisselend aan de linker- en de
rechterkant aandraaien
Alternare il serraggio delle viti
Apretar alternativamente
Aperte alternadamente
Dra åt växelvis
Kierrä vuorotellen
Pinguldage vaheldumisi
Pievēlciet pamišus
Užsukinėkite pakaitomis
Śruby dokręcaj naprzemiennie
Затягивайте попеременно

CZ
SK
SLO
HR
HU
GR
TR
中文
한국어
日本語
ไทย

Pokrętał bagażnika dokręcaj
dokręcaj naprzemiennie.
Dotahujte striedavo
Privijajte izmenično.
Naizmjenočno zategnite
Egymástól függetlenül
szorítandó
Σφιγχετε εναλλάξ
Dönüşümlü sıkın
交替拧紧
번갈아 가며 조이십시오.
交互に締め付けてください。
ชิ้นในแบบสลับ



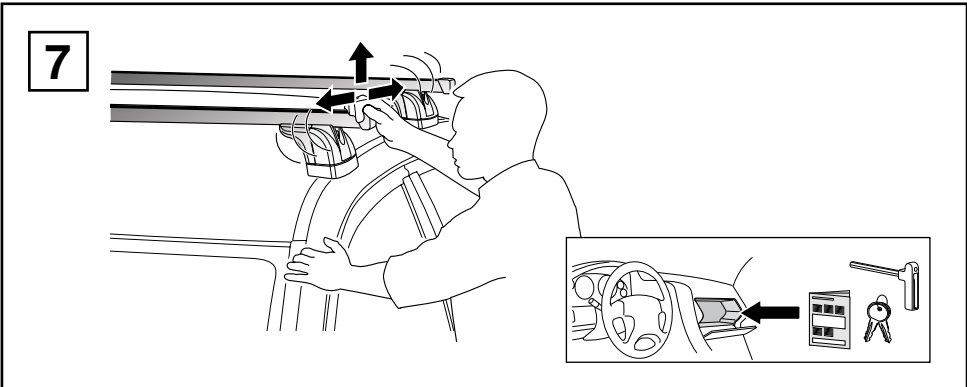
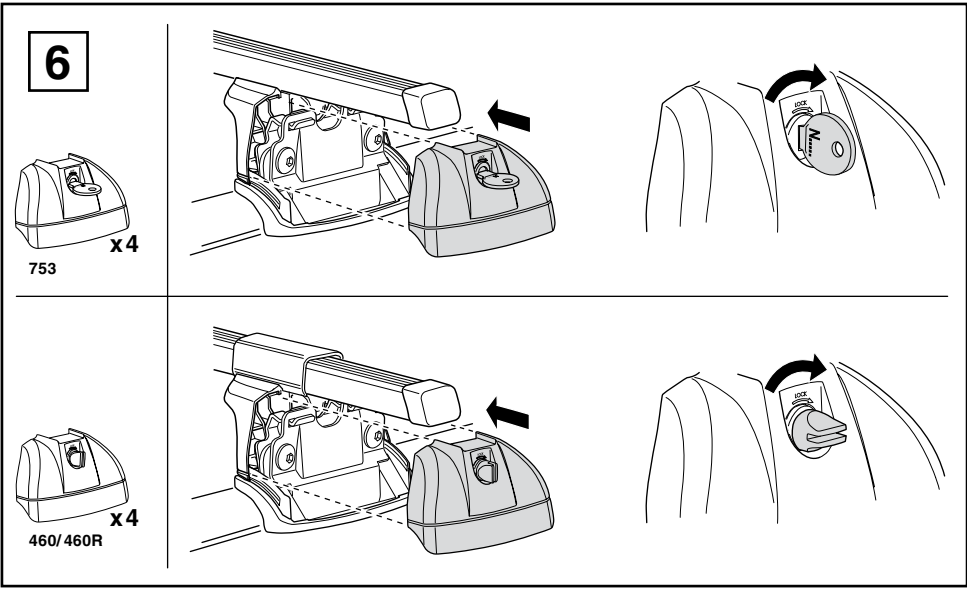
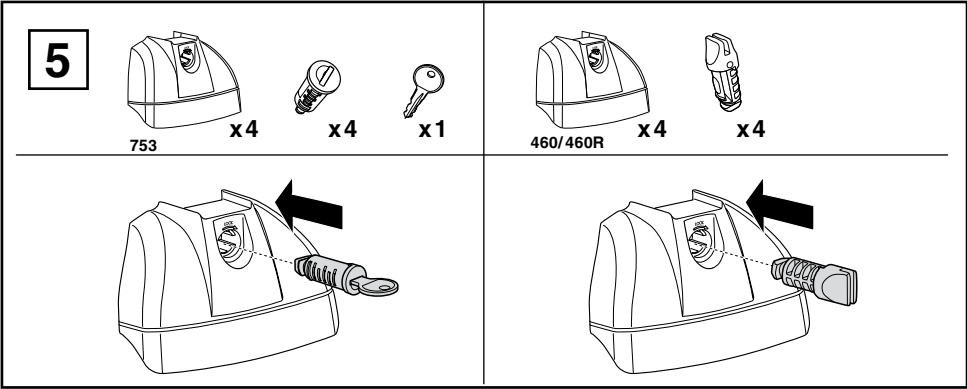

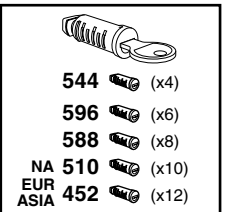
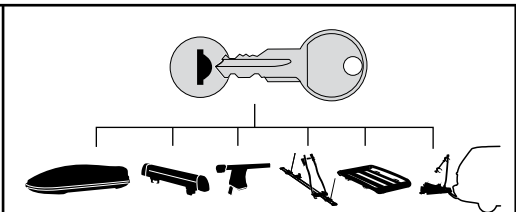
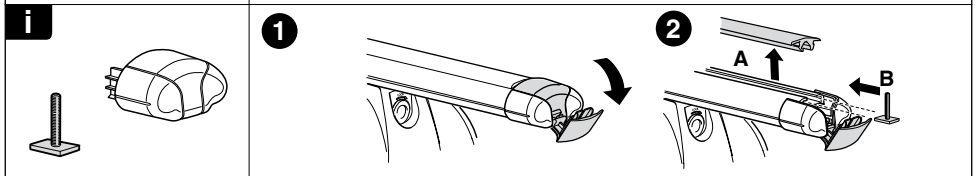
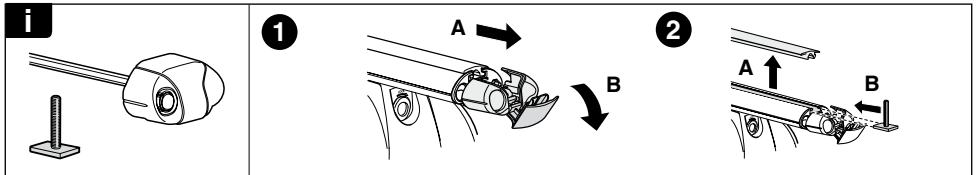
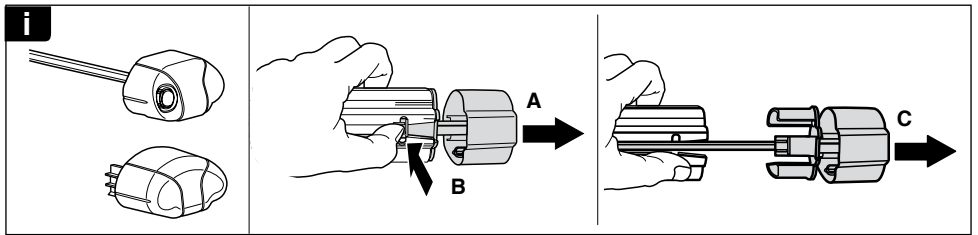
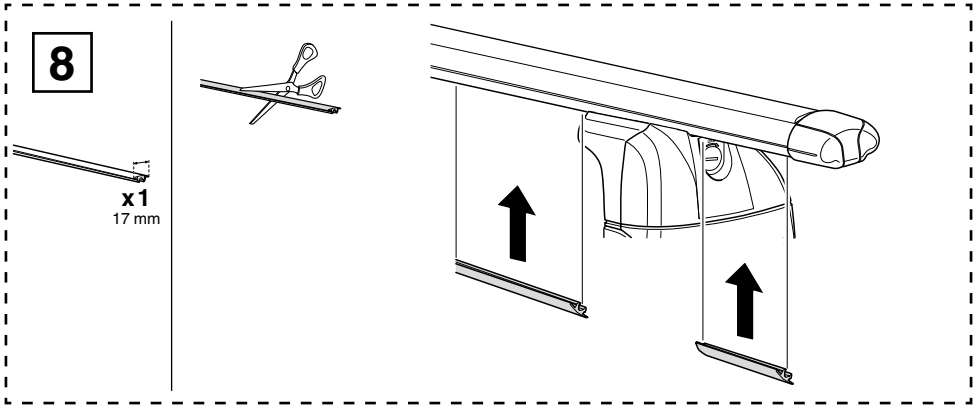

WW ▶ Thule Sweden AB, Box 69, 330 33 Hillerstorp, SWEDEN

NA ▶ Thule Inc., 42 Silvermine Road, Seymour, Connecticut 06483, USA

info@thule.com

customer.service@thule.com

www.thule.com