

# Kit 1592

**VOLKSWAGEN Passat, 4-dr Sedan, 05-09, 10- / \*06-**  
**\*North America**

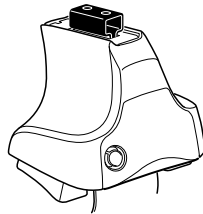

**754** Rapid System  
**480R** Rapid Traverse (North America)

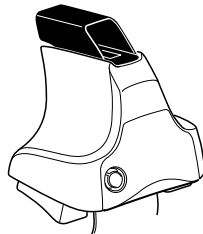
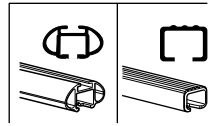

**480** Traverse (North America)

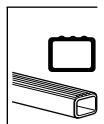

**Max.**  
**75 kg**  
**Max.**  
**165 lbs**

**km/h**  
**Mph**

**THULE**  
**Kit XXXX**  
**instructions**  
**THULE**

**x1**

**x4**

**754 Rapid System**

**x4**

**480R Rapid Traverse**  
**(North America)**

**x4**

**x4**

**754 Rapid System**  
**480R Rapid Traverse (North America)**

**x1**

**x4**

**480 Traverse (North America)**

**x4**

**x4**

**x2**

**x2**  
**23 mm**

**x2**  
**23 mm**

**x4**

**x4**

**x1**  
**17 mm**

**x2**  
**23 mm**

**x2**

**x2**

**x4**

**(North America)**

**x2**  
**23 mm**

**x2**

**x2**

**1094 x1**

**725 x1**

**1095 x1**

**726 x1**

**163 x2**

**164 x2**

**50993 x2**

**x1**

1

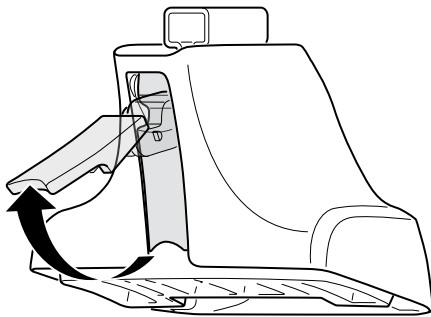

2



754 Rapid System  
480R Rapid Traverse  
(North America)

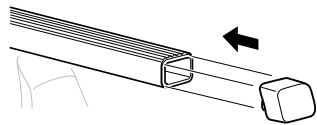
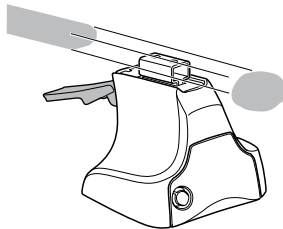

x4

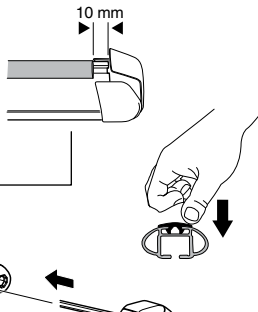
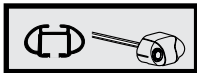

x4

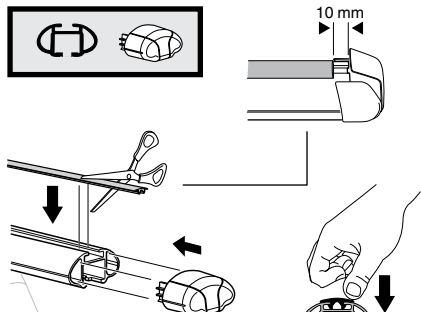
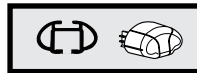

x4



480 Traverse  
(North America)

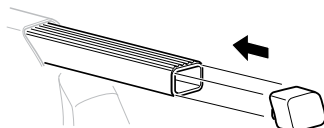
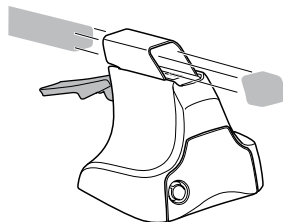

x4

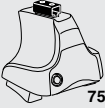
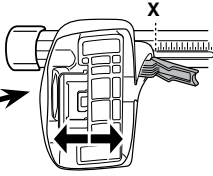
**3****754** Rapid System**X**

<b>VOLKSWAGEN Passat, 4-dr Sedan, 05-09, 10- / *06-</b>	<b>X</b>
	<b>40,5</b>

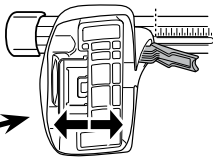
**Y**

<b>VOLKSWAGEN Passat, 4-dr Sedan, 05-09, 10- / *06-</b>	<b>Y</b>
	<b>39</b>

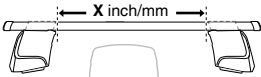
**3****480R** Rapid Traverse**480** Traverse**(North America)****X inch/mm**

	<b>X inch</b>	<b>X mm</b>
<b>VOLKSWAGEN Passat, 4-dr Sedan, 05-09, 10- / *06-</b>	<b>41 5/8"</b>	<b>1056 mm</b>

**Y inch/mm**

	<b>Y inch</b>	<b>Y mm</b>
<b>VOLKSWAGEN Passat, 4-dr Sedan, 05-09, 10- / *06-</b>	<b>41"</b>	<b>1041 mm</b>

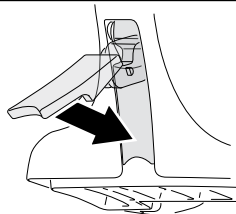
**4**

**5**

VOLKSWAGEN Passat, 4-dr Sedan, 05-09, 10- / \*06-

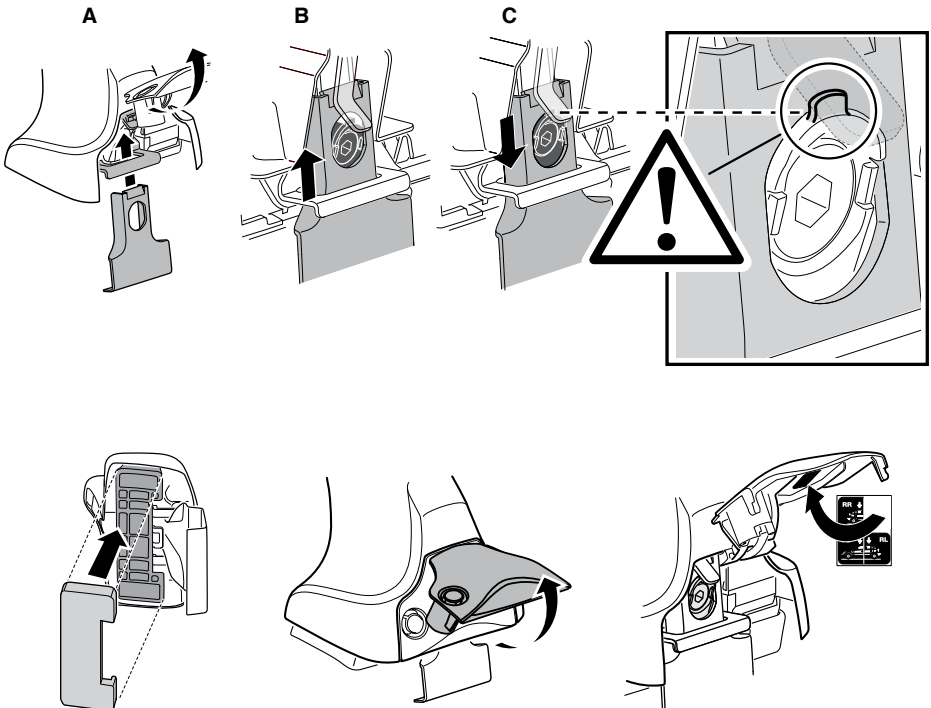
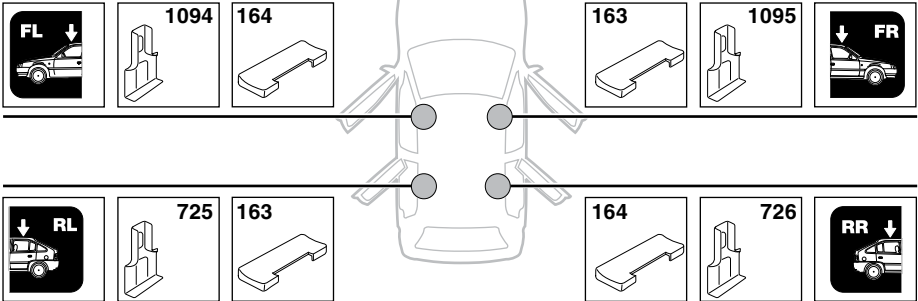

6

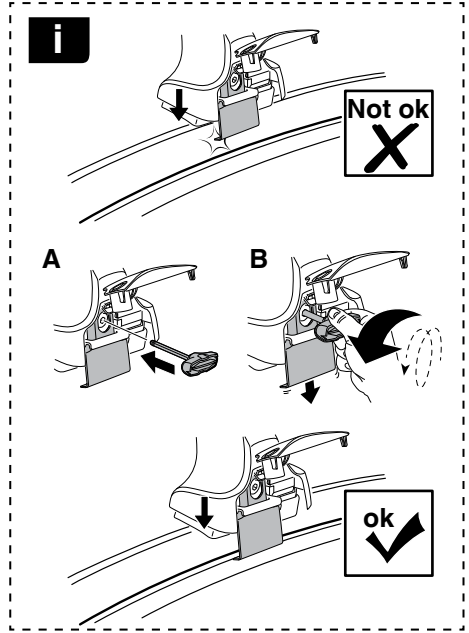
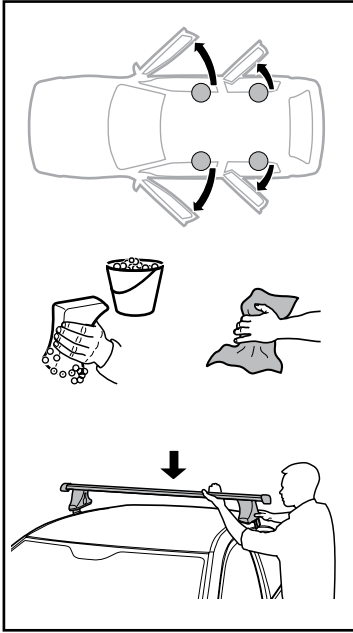

	X mm	Y mm	X inch	Y inch
VOLKSWAGEN Passat, 4-dr Sedan, 05-09, 10- / *06-	270 mm	775 mm	10 <sup>5</sup> / <sub>8</sub> "	30 <sup>1</sup> / <sub>2</sub> "

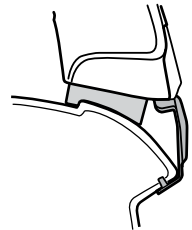
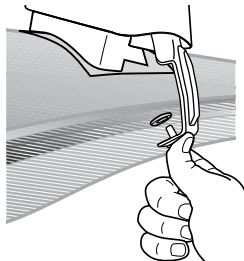
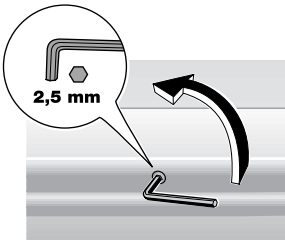
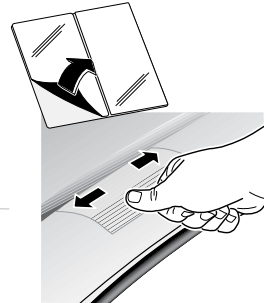
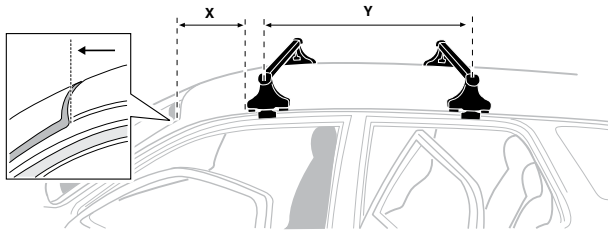

7

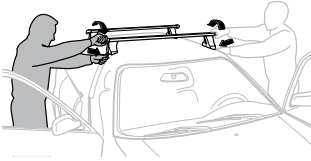

**GB/US** Tighten alternately  
**D** Die Schrauben abwechselnd anziehen  
**F** Serrer alternativement chaque côté  
**NL** Afwisselend aan de linker- en de rechterkant aandraaien  
**I** Alternare il serraggio delle viti  
**E** Apretar alternativamente  
**PT** Aperte alternadamente  
**S** Dra åt växelvis  
**FIN** Kierrä vuorotellen  
**EST** Pinguldage vaheldumisi  
**LAT** Pievelciēt pamišus  
**LIT** Užsukinėkite pakaitomis  
**PL** Śruby dokręcaj naprzemiennie  
**RU** Затягивайте попеременно

**CZ** Pokrétla bagazníka dokręcaj dokręcaj naprzemiennie.  
**SK** Doťahujte striedavo  
**SLO** Privijajte izmenično.  
**HR** Naizmjenično zategnite  
**HU** Egymástól függetlenül szorítandó  
**GR** Σφιγγεται εναλλάξ  
**TR** Dönüşümlü sıkın

**中文** 交替拧紧

**한국어** 번갈아 가며 조이십시오.

**日本語** 交互に締め付けてください。

**ไทย** ชั้้นในแบบสลับ

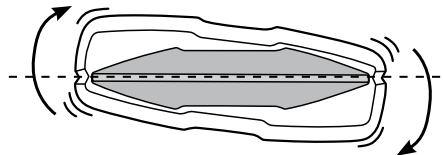
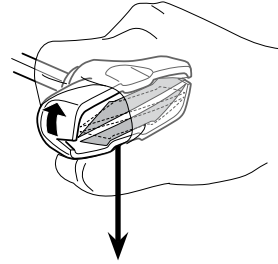
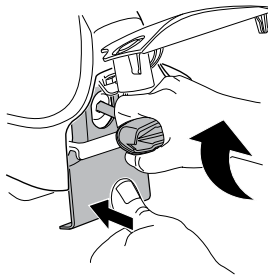
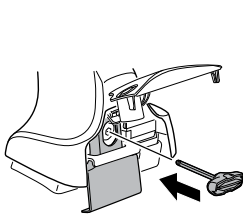

≈ 3 Nm

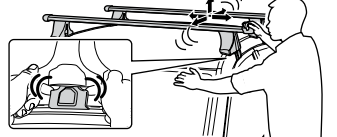
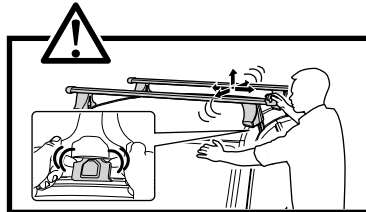
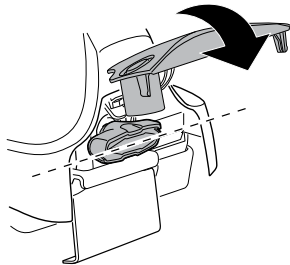

8



x1  
17 mm

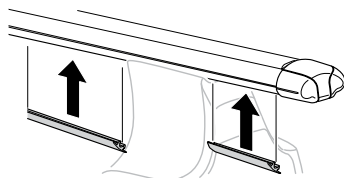

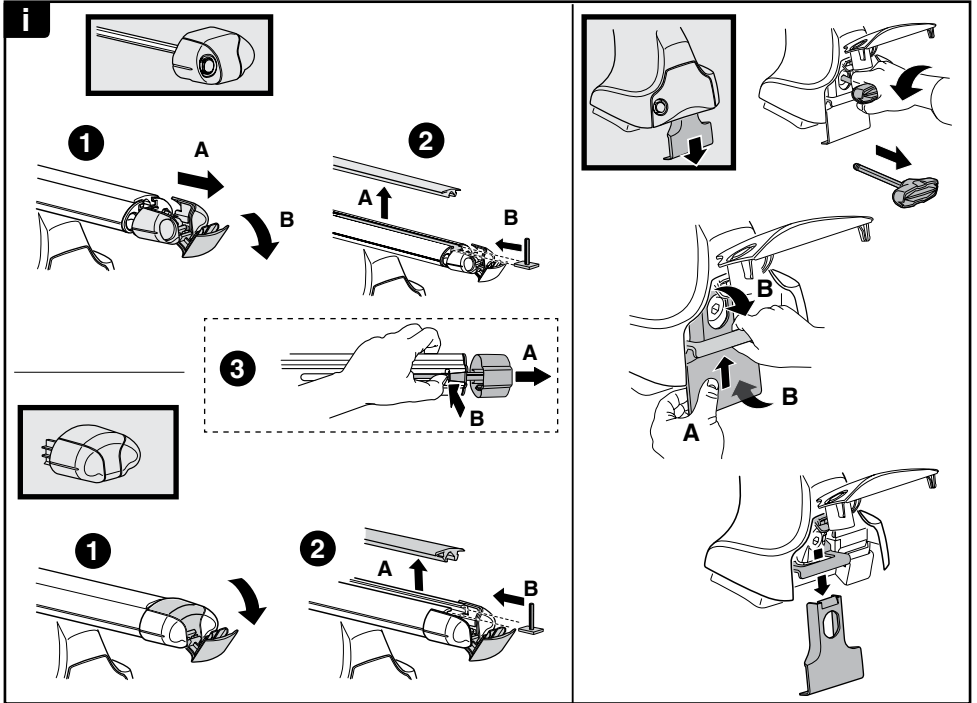
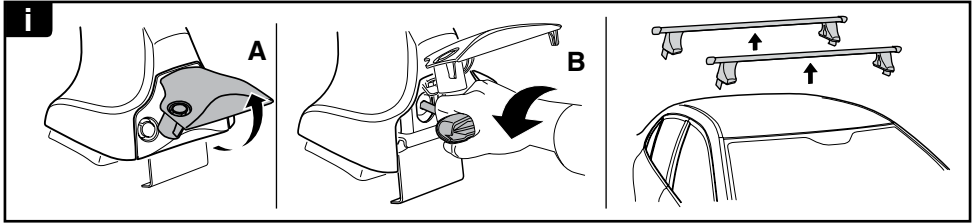

**THULE**  
SWEDEN  
**ONE  
KEY  
SYSTEM**

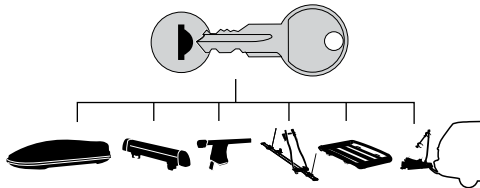

**544** (x4)

**596** (x6)

**588** (x8)

NA **510** (x10)

EUR **452** (x12)

ASIA

