

Kit 1438

LEXUS ES 350, 4-dr Sedan, *07-

TOYOTA Aurion, 4-dr Sedan, 06-

TOYOTA Camry, 4-dr Sedan, 06- / *07-

*North America

480R
754

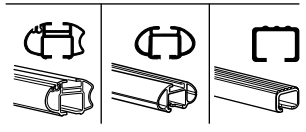
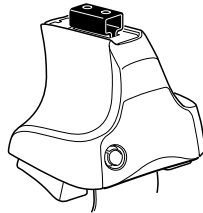

480

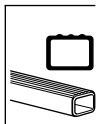
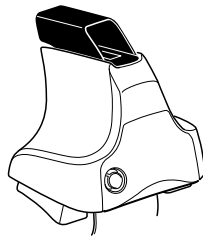

750

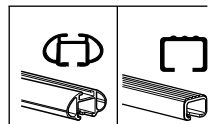
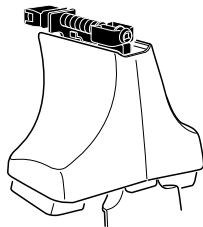

THULE[®]
SWEDEN

x1

x4

x4

x4

x4

480R/754

x1

x4

x4

x4

480

x1

x4

x4

750

x2	x2	x2	x2	x2
x2	x2	x2	x2	x2
x2	x4	x4	x4	x4
x4	x4	x4	x4	x4

04 x 2

88 x 4

120 x 1

121 x 1

x 1

Kit



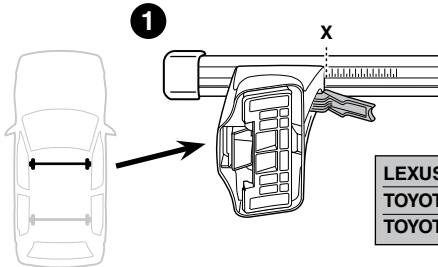

	X
LEXUS ES 350, 4-dr Sedan, *07-	38
TOYOTA Aurion, 4-dr Sedan, 06-	38
TOYOTA Camry, 4-dr Sedan, 06- / *07-	38

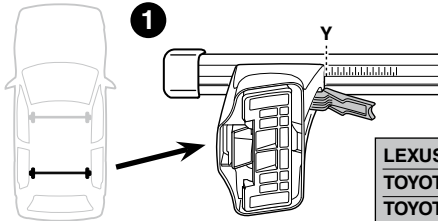
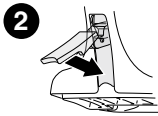

	Y
LEXUS ES 350, 4-dr Sedan, *07-	38,5
TOYOTA Aurion, 4-dr Sedan, 06-	38,5
TOYOTA Camry, 4-dr Sedan, 06- / *07-	38,5

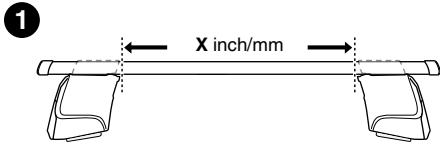
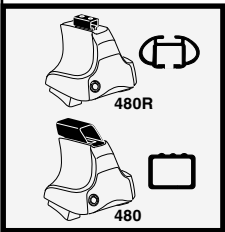

	X inch	X mm
LEXUS ES 350, 4-dr Sedan, *07-	40 5/8"	1031 mm
TOYOTA Aurion, 4-dr Sedan, 06-	40 5/8"	1031 mm
TOYOTA Camry, 4-dr Sedan, 06- / *07-	40 5/8"	1031 mm

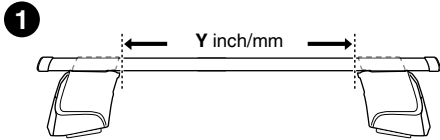
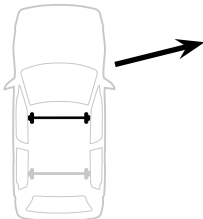
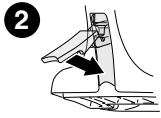

	Y inch	Y mm
LEXUS ES 350, 4-dr Sedan, *07-	40 3/4"	1036 mm
TOYOTA Aurion, 4-dr Sedan, 06-	40 3/4"	1036 mm
TOYOTA Camry, 4-dr Sedan, 06- / *07-	40 3/4"	1036 mm

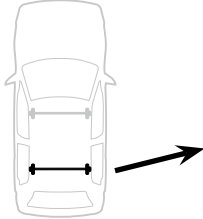
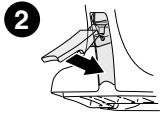

4

LEXUS ES 350, 4-dr Sedan, *07-
 TOYOTA Aurion, 4-dr Sedan, 06-
 TOYOTA Camry, 4-dr Sedan, 06- / *07-

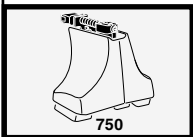
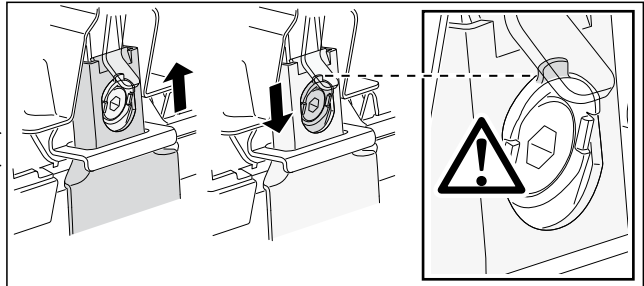
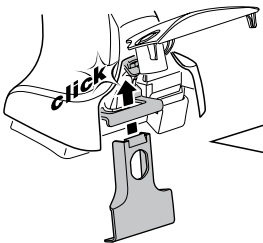
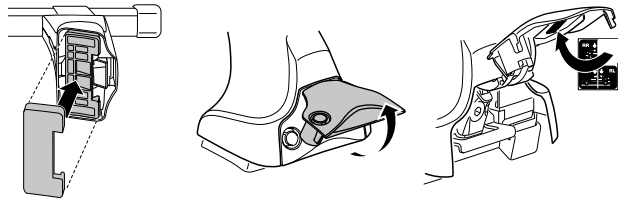
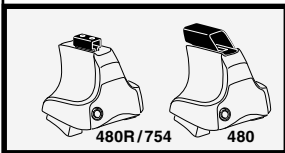
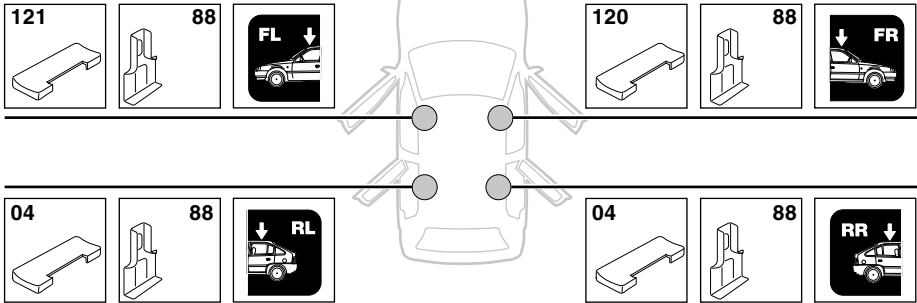

5



	X mm	Y mm	X inch	Y inch
LEXUS ES 350, 4-dr Sedan, *07-	230 mm	680 mm	9"	26 3/4"
TOYOTA Aurion, 4-dr Sedan, 06-	230 mm	680 mm	9"	26 3/4"
TOYOTA Camry, 4-dr Sedan, 06- / *07-	230 mm	680 mm	9"	26 3/4"

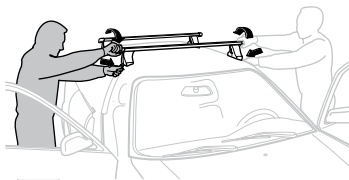
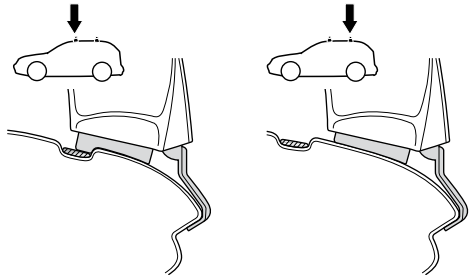
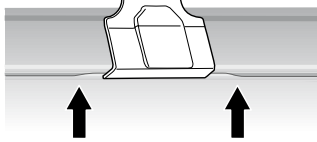
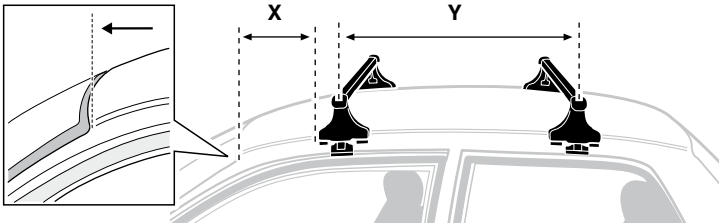

GB/US Tighten alternately

D Die Schrauben abwechselnd anziehen

F Serrer alternativement chaque côté

NL Afwisselend aan de linker- en de rechterkant aandraaien

I Alternare il serraggio delle viti

E Serrare alternativamente

PT Aperte alternadamente

S Dra åt växelvis

FIN Kierrä vuorotellen

EST Pinguldage vaheldumisi

LAT Pielieciet pamišus

LIT Užsukinėkite pakaitomis

PL Śruby dokręcaj naprzemiennie

RU Затягивайте попеременно

CZ Pokręťta bagażníka dokręcaj dokręcaj naprzemiennie.

SK Doťahujte striedavo

SLO Privijajte izmenično.

HR Naizmjenično zategnite

HU Egymástól függetlenül szorítandó

GR Σφίγγετε εναλλάξ

TR Dönüşümlü sıkın

中文 交替拧紧

한국어 번갈아 가며 조이십시오.

日本語 交互に締め付けてください。

ไทย ชั้ไนแบบสลับ

6



480R/754



480



*
3 Nm



*



*
≈ 3 Nm

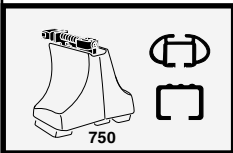

750

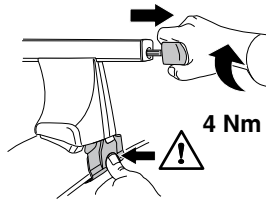

4 Nm

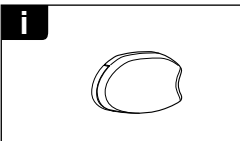
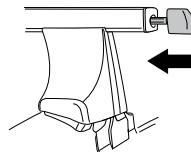

i

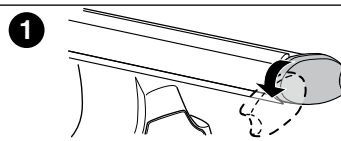

1

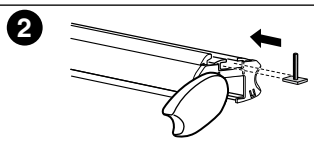

2

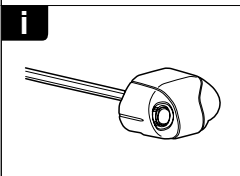

i

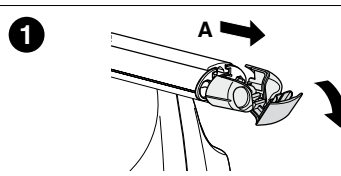

1

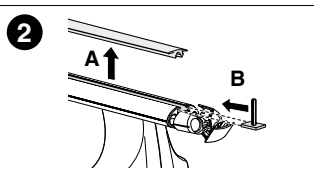

2

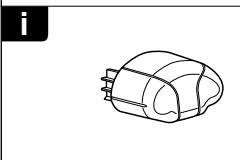

i

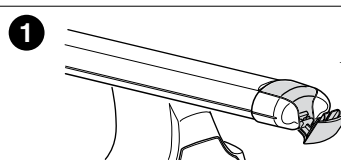

1

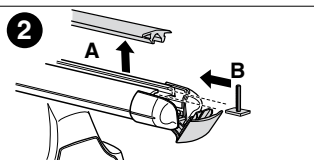

2



THULE
SWEDEN
**ONE
KEY
SYSTEM**



- 544 (x4)
- 596 (x6)
- 588 (x8)
- NA 510 (x10)
- EUR 452 (x12)
- ASIA



WW ▶ Thule Sweden AB, Box 69, 330 33 Hillerstorp, SWEDEN
NA ▶ Thule Inc., 42 Silvermine Road, Seymour, Connecticut 06483, USA

info@thule.com
customer.service@thule.com

www.thule.com